



# TEST REPORT

**Reference No.**..... : WTX24X09214732W001  
**Manufacturer** ..... : Descartes Systems Group Inc.  
**Address** ..... : 105 Trafalgar Street, Floor 2, Nelson, Tasman 7010, New Zealand  
**Product Name** ..... : Pallet tag  
**Model No.**..... : PLT005  
  
**Standards** ..... : **ETSI EN 300 328 V2.2.2 (2019-07)**  
  
**Date of Receipt sample** .... : 2024-09-12  
**Date of Test**..... : 2024-09-12 to 2024-09-25  
**Date of Issue** ..... : 2024-09-25  
**Test Report Form No.** ..... : WTX\_ ETSI EN 300 328\_2019W  
**Test Result**..... : **Pass**

**Remarks:**

The results shown in this test report refer only to the sample(s) tested, this test report cannot be reproduced, except in full, without prior written permission of the company. The report would be invalid without specific stamp of test institute and the signatures of approver.

**Prepared By:**

**Waltek Testing Group (Shenzhen) Co., Ltd.**

Address: 1/F., Room 101, Building 1, Hongwei Industrial Park, Liuxian 2nd Road,  
Block 70 Bao'an District, Shenzhen, Guangdong, China

Tel.: +86-755-33663308 Fax.: +86-755-33663309 Email: sem@waltek.com.cn

Tested by:

Mike Shi

Approved by:

Jason Su



## **TABLE OF CONTENTS**

<b>1. GENERAL INFORMATION.....</b>	<b>4</b>
1.1 PRODUCT DESCRIPTION FOR EQUIPMENT UNDER TEST (EUT).....	4
1.2 TEST STANDARDS.....	6
1.3 TEST METHODOLOGY.....	6
1.4 TEST FACILITY.....	6
1.5 EUT SETUP AND TEST MODE.....	7
1.6 MEASUREMENT UNCERTAINTY.....	8
1.7 TEST EQUIPMENT LIST AND DETAILS.....	9
<b>2. SUMMARY OF TEST RESULTS.....</b>	<b>11</b>
<b>3. RF OUTPUT POWER.....</b>	<b>12</b>
3.1 STANDARD APPLICABLE.....	12
3.2 TEST PROCEDURE.....	12
3.3 SUMMARY OF TEST RESULTS.....	13
<b>4. POWER SPECTRAL DENSITY.....</b>	<b>14</b>
4.1 STANDARD APPLICABLE.....	14
4.2 TEST PROCEDURE.....	14
4.3 SUMMARY OF TEST RESULTS.....	15
<b>5. OCCUPIED CHANNEL BANDWIDTH.....</b>	<b>16</b>
5.1 STANDARD APPLICATION.....	16
5.2 TEST PROCEDURE.....	16
5.3 SUMMARY OF TEST RESULTS/PLOTS.....	16
<b>6. TRANSMITTER UNWANTED EMISSIONS IN THE OUT-OF-BAND DOMAIN.....</b>	<b>17</b>
6.1 STANDARD APPLICATION.....	17
6.2 TEST PROCEDURE.....	17
6.3 SUMMARY OF TEST RESULTS/PLOTS.....	19
<b>7. TRANSMITTER UNWANTED EMISSIONS IN THE SPURIOUS DOMAIN.....</b>	<b>20</b>
7.1 STANDARD APPLICABLE.....	20
7.2 TEST PROCEDURE.....	20
7.3 SUMMARY OF TEST RESULTS/PLOTS.....	20
<b>8. RECEIVER SPURIOUS EMISSIONS.....</b>	<b>30</b>
8.1 STANDARD APPLICABLE.....	30
8.2 TEST PROCEDURE.....	30
8.3 SUMMARY OF TEST RESULTS/PLOTS.....	30
<b>9. RECEIVER BLOCKING.....</b>	<b>36</b>
9.1 STANDARD APPLICATION.....	36
9.2 TEST PROCEDURE.....	39
9.3 TEST SETUP.....	39
9.4 SUMMARY OF TEST RESULTS/PLOTS.....	40
<b>EXHIBIT 1 - EUT PHOTOGRAPHS.....</b>	<b>41</b>
<b>EXHIBIT 2 - TEST SETUP PHOTO.....</b>	<b>42</b>



## Report version

Version No.	Date of issue	Description
Rev.00	2024-09-25	Original
/	/	/

# WALTEK



## 1. GENERAL INFORMATION

### 1.1 Product Description for Equipment Under Test (EUT)

General Description of EUT	
Product Name:	Pallet tag
Trade Name:	/
Model No.:	PLT005
Adding Model(s):	/
Rated Voltage:	DC3V
Battery Capacity:	/
Adapter Model:	/
Software Version:	plt005_v65.1.1
Hardware Version:	1.0
Radio Technology:	Bluetooth V5.3(BLE Mode)
Operation Frequency:	2402MHz-2480MHz
Modulation:	GFSK
Antenna Type:	Mini Patch Antenna
Antenna Gain:	3.5dBi
<p><i>Note: The Antenna Gain is provided by the customer and can affect the validity of results. The test data is gathered from a production sample, provided by the manufacturer.</i></p>	

E.1 Product Information (Bluetooth V5.3)	
a) Type of modulation:	<input type="checkbox"/> FHSS <input checked="" type="checkbox"/> other forms of modulation
b) Adaptive / non-adaptive:	Adaptive equipment without a non-adaptive mode
c) In case of adaptive equipment:	The equipment has implemented an LBT based DAA mechanism
d) In case of non-adaptive equipment:	No
e) The worst case operational mode for each of the following tests	
RF output power:	BLE
Power spectrum density:	BLE
Occupied channel bandwidth:	BLE
Transmitter unwanted emissions in the OOB domain:	BLE
Transmitter unwanted emissions in the spurious domain:	BLE
Receiver spurious emissions:	BLE
f) Operating mode(antenna):	Single Antenna Equipment



<b>g)</b> In case of smart antenna Systems:	No
<b>h)</b> Operating frequency range(s) of the equipment:	2402MHz-2480MHz
<b>i)</b> Occupied channel bandwidth(s):	Bandwidth 1(Min): 1Mbps:1.05MHz 2Mbps:2.05MHz Bandwidth 2(Max): 1Mbps:1.07MHz 2Mbps:2.06MHz
<b>j)</b> Type of equipment:	<input checked="" type="checkbox"/> Stand-alone <input type="checkbox"/> Combined equipment <input type="checkbox"/> Plug-in device
<b>k)</b> The extreme operating conditions	
Extreme voltage range:	Please refer to Section 1.5
Extreme temperature range:	Please refer to Section 1.5
<b>l)</b> The intended combination(s) of the radio equipment power settings and one or more antenna assemblies and their corresponding e.i.r.p levels	
Antenna type:	<input checked="" type="checkbox"/> Ceramic Antenna <input type="checkbox"/> Dedicated Antennas
Antenna gain:	3.5dBi
<b>m)</b> Nominal voltage:	Please refer to Section 1.5
<b>n)</b> Describe the test modes available which can facilitate testing:	Please refer to Section 1.5
<b>o)</b> The equipment type	Bluetooth
<b>E.2 Power Level Setting</b>	
Highest EIRP value:	1Mbps:7.49dBm 2Mbps:7.48dBm
Conducted power:	1Mbps:3.99dBm 2Mbps:3.98dBm
Listed as power setting:	Default
<b>E.3 Additional Information</b>	
Modulation:	GFSK
Unmodulated modes:	No
Duty cycle:	Continuous operation possible for testing purposes
Type of the UUT:	Production models
Supporting equipment:	Combined equipment



## 1.2 Test Standards

The tests were performed according to following standards:

**ETSI EN 300 328 V2.2.2 (2019-07):** Wideband transmission systems; Data transmission equipment operating in the 2.4 GHz band; Harmonised Standard for access to radio spectrum.

**Maintenance of compliance** is the responsibility of the manufacturer. Any modification of the product maybe which result in lowering the emission/immunity should be checked to ensure compliance has been maintained.

## 1.3 Test Methodology

All measurements contained in this report were conducted with ETSI EN 300328, the equipment under test (EUT) was configured to measure its highest possible emission level. For more detail refer to the Operating Instructions.

## 1.4 Test Facility

### Address of the test laboratory

Laboratory: Waltek Testing Group (Shenzhen) Co., Ltd.

Address: 1/F., Room 101, Building 1, Hongwei Industrial Park, Liuxian 2nd Road, Block 70 Bao'an District, Shenzhen, Guangdong, China

### FCC – Registration No.: 125990

Waltek Testing Group (Shenzhen) Co., Ltd. EMC Laboratory has been registered and fully described in a report filed with the FCC (Federal Communications Commission). The acceptance letter from the FCC is maintained in our files. The Designation Number is CN5010, and Test Firm Registration Number is 125990.

### Industry Canada (IC) Registration No.: 11464A

The 3m Semi-anechoic chamber of Waltek Testing Group (Shenzhen) Co., Ltd. has been registered by Certification and Engineering Bureau of Industry Canada for radio equipment testing with Registration No.: 11464A.



## 1.5 EUT Setup and Test Mode

The RF testing sample was used for the purpose of the measurements. All testing was performed under the maximum output power level, with a duty cycle equal to 100%, and measured the highest emission levels, more detailed description as follows:

Test Mode List		
Test Mode	Description	Remark
TM1	BLE	2402/2440/2480MHz

	NTNV	LTVN	HTNV
Temperature (°C)	25	-10	+50
Voltage (V)	DC3V		
Relative Humidity:			45 %.
ATM Pressure:			1019 mbar

EUT Cable List and Details			
Cable Description	Length (m)	Shielded/Unshielded	With / Without Ferrite
/	/	/	/

Special Cable List and Details			
Cable Description	Length (m)	Shielded/Unshielded	With / Without Ferrite
/	/	/	/

Auxiliary Equipment List and Details			
Description	Manufacturer	Model	Serial Number
Computer	Lenovo	L13 Yoga	/



## 1.6 Measurement Uncertainty

Measurement uncertainty		
Parameter	Uncertainty	Note
Radio frequency	$\pm 0.4$ ppm	(1)
Conducted RF Output Power	$\pm 0.42$ dB	(1)
Occupied Bandwidth	$\pm 1 \times 10^{-7}$	(1)
Conducted Power Spectral Density	$\pm 0.70$ dB	(1)
Conducted Spurious Emission	$\pm 2.17$ dB	(1)
Radiated Spurious Emissions	30-200MHz $\pm 4.52$ dB	(1)
	0.2-1GHz $\pm 5.56$ dB	(1)
	1-6GHz $\pm 3.84$ dB	(1)
	6-18GHz $\pm 3.92$ dB	(1)

(1) This uncertainty represents an expanded uncertainty expressed at approximately the 95% confidence level using a coverage factor of  $k=1.96$ .

# WALTEK





## 1.7 Test Equipment List and Details

Description	Manufacturer	Model	Serial Number	Cal Date	Due Date
Spectrum Analyzer	Agilent	N9020A	US47140102	2024-03-19	2025-03-18
Signal Generator	Agilent	83752A	3610A01453	2024-02-24	2025-02-23
Vector Signal Generator	Agilent	N5182A	MY47070202	2024-02-24	2025-02-23
Power Sensor	Agilent	U2021XA	MY54250019	2024-02-24	2025-02-23
Power Sensor	Agilent	U2021XA	MY54250021	2024-02-24	2025-02-23
Simultaneous Sampling	Agilent	U2531A	TW54243509	2024-02-24	2025-02-23
Temperature&Humidity Chamber	/	HTC-1	/	2024-02-24	2025-02-23
Universal Radio Communication Tester	Rohde & Schwarz	CMW500	148650	2024-02-24	2025-02-23
<input type="checkbox"/> Chamber A: Below 1GHz					
Spectrum Analyzer	Rohde & Schwarz	FSP30	836079/035	2024-02-24	2025-02-23
EMI Test Receiver	Rohde & Schwarz	ESPI	101611	2024-03-19	2025-03-18
Amplifier	HP	8447F	2805A03475	2024-02-24	2025-02-23
Loop Antenna	Schwarz beck	FMZB 1516	9773	2024-02-26	2025-02-25
Broadband Antenna	Schwarz beck	VULB9163	9163-333	2024-02-24	2025-02-23
<input type="checkbox"/> Chamber A: Above 1GHz					
Spectrum Analyzer	Rohde & Schwarz	FSP30	836079/035	2024-02-24	2025-02-23
Spectrum Analyzer	Rohde & Schwarz	FSP40	100612	2024-02-27	2025-02-26
EMI Test Receiver	Rohde & Schwarz	ESPI	101611	2024-03-19	2025-03-18
Amplifier	C&D	PAP-1G18	2002	2024-02-27	2025-02-26
Horn Antenna	ETS	3117	00086197	2024-02-26	2025-02-25
DRG Horn Antenna	A.H. SYSTEMS	SAS-574	571	2024-03-17	2025-03-16
Pre-amplifier	Schwarzbeck	BBV 9721	9721-031	2024-02-29	2025-02-28
<input type="checkbox"/> Chamber B:Below 1GHz					
Trilog Broadband Antenna	Schwarz beck	VULB9163(B)	9163-635	2024-03-17	2027-03-16
Amplifier	Agilent	8447D	2944A10179	2024-02-24	2025-02-23
EMI Test Receiver	Rohde & Schwarz	ESPI	101391	2024-02-24	2025-02-23
<input checked="" type="checkbox"/> Chamber C:Below 1GHz					
EMI Test Receiver	Rohde & Schwarz	ESIB 26	100401	2024-02-27	2025-02-26
Trilog Broadband Antenna	Schwarz beck	VULB 9168	1194	2024-04-18	2027-04-17
Loop Antenna	Schwarz beck	FMZB 1516	9773	2024-02-26	2025-02-25
Amplifier	HP	8447F	2944A03869	2024-02-24	2025-02-23



<input checked="" type="checkbox"/> Chamber C: Above 1GHz					
EMI Test Receiver	Rohde & Schwarz	ESIB 26	100401	2024-02-27	2025-02-26
Horn Antenna	POAM	RTF-118A	1820	2023-03-10	2026-03-09
Amplifier	Tonscend	TAP01018050	AP22E806235	2024-02-27	2025-02-26
DRG Horn Antenna	A.H. SYSTEMS	SAS-574	571	2024-03-17	2025-03-16
Pre-amplifier	Schwarzbeck	BBV 9721	9721-031	2024-02-29	2025-02-28

Software List			
Description	Manufacturer	Model	Version
EMI Test Software (Radiated Emission A)	Farad	EZ-EMC	RA-03A1 (1.1.4.2)
EMI Test Software (Radiated Emission B)	Farad	EZ-EMC	RA-03A1 (1.1.4.2)
EMI Test Software (Radiated Emission C)	Farad	EZ-EMC	RA-03A1-2 (1.1.4.2)
RF Test System	Tonscend	JS1120-3	V3.5.39
RF Test System	Ascentest	AT890	V3.0

\*Remark: indicates software version used in the compliance certification testing



## 2. SUMMARY OF TEST RESULTS

Standards	Reference	Description of Test Item	Result
EN 300 328	4.3.1.2 / 4.3.2.2	RF Output Power	Passed
	4.3.2.3	Power Spectral Density	Passed
	4.3.1.3 / 4.3.2.4	Duty Cycle, Tx-sequence, Tx-gap	N/A
	4.3.1.4	Accumulated Transmit Time, Frequency Occupation and Hopping Sequence	N/A
	4.3.1.5	Hopping Frequency Separation	N/A
	4.3.1.6 / 4.3.2.5	Medium Utilisation (MU) Factor	N/A
	4.3.1.7 / 4.3.2.6	Adaptivity (Adaptive Frequency Hopping)	N/A
	4.3.1.8 / 4.3.2.7	Occupied Channel Bandwidth	Passed
	4.3.1.9 / 4.3.2.8	Transmitter Unwanted Emissions in the Out-of-band Domain	Passed
	4.3.1.10 / 4.3.2.9	Transmitter Unwanted Emissions in the Spurious Domain	Passed
	4.3.1.11 / 4.3.2.10	Receiver Spurious Emissions	Passed
	4.3.1.12 / 4.3.2.11	Receiver Blocking	Passed
	4.3.1.13 / 4.3.2.12	Geo-location capability	N/A
<p>Passed: The EUT complies with the essential requirements in the standard.  Failed: The EUT does not comply with the essential requirements in the standard.  N/A: Not applicable.</p>			



### 3. RF OUTPUT POWER

---

#### 3.1 Standard Applicable

According to Section 4.3.1.2.3, the maximum RF output power for adaptive Frequency Hopping equipment shall be equal to or less than 20 dBm. The maximum RF output power for non-adaptive Frequency Hopping equipment, shall be declared by the supplier. The maximum RF output power for this equipment shall be equal to or less than the value declared by the supplier. This declared value shall be equal to or less than 20 dBm.

According to Section 4.3.2.2.3, for adaptive equipment using wide band modulations other than FHSS, the maximum RF output power shall be 20 dBm. The maximum RF output power for non-adaptive equipment shall be declared by the supplier and shall not exceed 20 dBm. For non-adaptive equipment using wide band modulations other than FHSS, the maximum RF output power shall be equal to or less than the value declared by the supplier.

This limit shall apply for any combination of power level and intended antenna assembly.

#### 3.2 Test Procedure

According to section 5.4.2.2.1.2 of the standard EN 300328, the test procedure shall be as follows:

##### Step 1:

- Use a fast power sensor suitable for 2,4 GHz and capable of 1 MS/s.
- Use the following settings: - Sample speed 1 MS/s or faster.
- The samples must represent the power of the signal.
- Measurement duration: For non-adaptive equipment: equal to the observation period defined in clauses 4.3.1.3.2 or clause 4.3.2.4.2. For adaptive equipment, the measurement duration shall be long enough to ensure a minimum number of bursts (at least 10) are captured.

NOTE 1: For adaptive equipment, to increase the measurement accuracy, a higher number of bursts may be used.

##### Step 2:

- For conducted measurements on devices with one transmit chain:
  - Connect the power sensor to the transmit port, sample the transmit signal and store the raw data. Use these stored samples in all following steps.
- For conducted measurements on devices with multiple transmit chains:
  - Connect one power sensor to each transmit port for a synchronous measurement on all transmit ports.
  - Trigger the power sensors so that they start sampling at the same time. Make sure the time difference between the samples of all sensors is less than half the time between two samples.
  - For each individual sampling point (time domain), sum the coincident power samples of all ports and store them. Use these summed samples in all following steps..



Reference No.: WTX24X09214732W001

**Step 3:**

- Find the start and stop times of each burst in the stored measurement samples.

The start and stop times are defined as the points where the power is at least 30 dB below the highest value of the stored samples in step 2.

NOTE 2: In case of insufficient dynamic range, the value of 30 dB may need to be reduced appropriately.

**Step 4:**

- Between the start and stop times of each individual burst calculate the RMS power over the burst using the formula below. Save these Pburst values, as well as the start and stop times for each burst.

$$P_{burst} = \frac{1}{k} \sum_{n=1}^k P_{sample}(n)$$

with 'k' being the total number of samples and 'n' the actual sample number

**Step 5:**

- The highest of all Pburst values (value "A" in dBm) will be used for maximum e.i.r.p. calculations.

**Step 6:**

- Add the (stated) antenna assembly gain "G" in dBi of the individual antenna.
- If applicable, add the additional beamforming gain "Y" in dB.
- If more than one antenna assembly is intended for this power setting, the maximum overall antenna gain (G or G + Y) shall be used.
- The RF Output Power (P) shall be calculated using the formula below:  $P = A + G + Y$
- This value, which shall comply with the limit given in clause 4.3.1.2.3 or clause 4.3.2.2.3, shall be recorded in the test report.

### 3.3 Summary of Test Results

Please refer to Appendix A



## 4. POWER SPECTRAL DENSITY

---

### 4.1 Standard Applicable

According to Section 4.3.2.3.3, For equipment using wide band modulations other than FHSS, the maximum Power Spectral Density is limited to 10dBm per MHz.

### 4.2 Test Procedure

According to section 5.4.3.2.1 of the standard EN 300328, the test procedure shall be as follows:

#### Step 1:

Connect the UUT to the spectrum analyser and use the following settings:

- Start Frequency: 2 400MHz
- Stop Frequency: 2 483.5MHz
- Resolution BW: 10kHz
- Video BW: 30kHz
- Sweep Points: > 8 350

NOTE: For spectrum analysers not supporting this number of sweep points, the frequency band may be segmented.

- Detector: RMS
- Trace Mode: Max Hold
- Sweep time: 10 s; the sweep time may be increased further until a value where the sweep time has no impact on the RMS value of the signal

For non-continuous signals, wait for the trace to stabilize.

Save the data (trace data) set to a file.

#### Step 2:

For conducted measurements on smart antenna systems using either operating mode 2 or operating mode 3 (see clause 5.1.3.2), repeat the measurement for each of the transmit ports. For each sampling point (frequency domain), add up the coincident power values (in mW) for the different transmit chains and use this as the new data set.

#### Step 3:

Add up the values for power for all the samples in the file using the formula below.

$$P_{Sum} = \sum_{n=1}^k P_{sample}(n)$$

with 'k' being the total number of samples and 'n' the actual sample number

#### Step 4:

Normalize the individual values for power (in dBm) so that the sum is equal to the RF Output Power (e.i.r.p.) measured in clause 5.3.2 and save the corrected data. The following formulas can be used:

$$C_{Corr} = P_{Sum} - P_{e.i.r.p.}$$

$$P_{Samplecorr}(n) = P_{Sample}(n) - C_{Corr}$$



with 'n' being the actual sample number

**Step 5:**

Starting from the first sample  $P_{\text{Samplecorr}}(n)$  (lowest frequency), add up the power (in mW) of the following samples representing a 1 MHz segment and record the results for power and position (i.e. sample #1 to sample #100). This is the Power Spectral Density (e.i.r.p.) for the first 1 MHz segment which shall be recorded.

**Step 6:**

Shift the start point of the samples added up in step 5 by one sample and repeat the procedure in step 5 (i.e. sample #2 to sample #101).

**Step 7:**

Repeat step 6 until the end of the data set and record the Power Spectral Density values for each of the 1 MHz segments.

From all the recorded results, the highest value is the maximum Power Spectral Density for the UUT. This value, which shall comply with the limit given in clause 4.3.2.3.3, shall be recorded in the test report.

RBW/VBW=10/30kHz

### 4.3 Summary of Test Results

Please refer to Appendix B

# WALTEK



## 5. OCCUPIED CHANNEL BANDWIDTH

---

### 5.1 Standard Application

According to section 4.3.1.8.3, the Occupied Channel Bandwidth for each hopping frequency shall fall completely within the band given in clause 1.

For non-adaptive Frequency Hopping equipment with e.i.r.p greater than 10 dBm, the Occupied Channel Bandwidth for every occupied hopping frequency shall be equal to or less than the value declared by the supplier. This declared value shall not be greater than 5 MHz.

According to section 4.3.2.7.3, the Occupied Channel Bandwidth shall fall completely within the band given in clause 1. In addition, for non-adaptive systems using wide band modulations other than FHSS and with e.i.r.p greater than 10 dBm, the occupied channel bandwidth shall be less than 20 MHz.

### 5.2 Test procedure

According to the section 5.4.7.2.1, the measurement procedure shall be as follows:

#### Step 1:

Connect the UUT to the spectrum analyser and use the following settings:

- Centre Frequency: The centre frequency of the channel under test
- Resolution BW: ~ 1 % of the span without going below 1 %
- Video BW:  $3 \times \text{RBW}$
- Frequency Span for frequency hopping equipment: Lowest frequency separation that is used within the hopping sequence
- Frequency Span for other types of equipment:  $2 \times \text{Nominal Channel Bandwidth}$  (e.g. 40 MHz for a 20 MHz channel)
- Detector Mode: RMS
- Trace Mode: Max Hold
- Sweep time: 1 s

#### Step 2:

Wait until the trace is completed.

Find the peak value of the trace and place the analyser marker on this peak.

#### Step 3:

Use the 99 % bandwidth function of the spectrum analyser to measure the Occupied Channel Bandwidth of the UUT. This value shall be recorded.

### 5.3 Summary of Test Results/Plots

**Please refer to Appendix C**





## 6. TRANSMITTER UNWANTED EMISSIONS IN THE OUT-OF-BAND DOMAIN

### 6.1 Standard Application

According to section 4.3.1.9.3&4.3.2.8.3, the transmitter unwanted emissions in the out-of-band domain but outside the allocated band, shall not exceed the values provided by the mask in figure below:

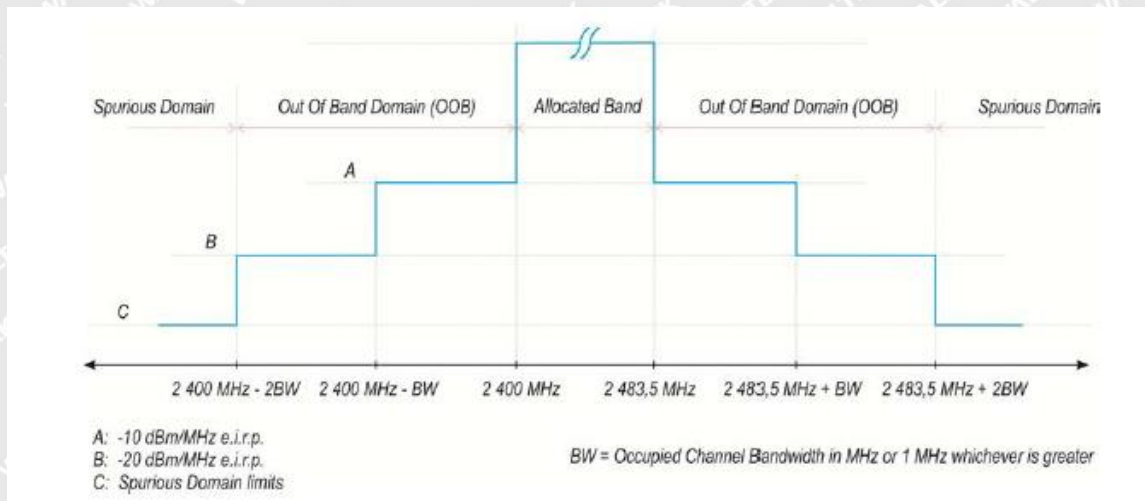

Within the 2400MHz to 2483.5MHz band, the Out-of-band emissions are fulfilled by compliance with the Occupied Channel Bandwidth requirement.

### 6.2 Test procedure

According to the section 5.4.8.2.1, the measurement procedure shall be as follows:

The Out-of-band emissions within the different horizontal segments of the mask provided in figures 1 and 3 shall be measured using the steps below. This method assumes the spectrum analyser is equipped with the Time Domain Power option.

#### Step 1:

- Connect the UUT to the spectrum analyser and use the following settings:
- Centre Frequency: 2484MHz
- Span: 0Hz
- Resolution BW: 1MHz
- Filter mode: Channel filter
- Video BW: 3 MHz
- Detector Mode: RMS
- Trace Mode: Max Hold
- Sweep Mode: Continuous
- Sweep Points: Sweep Time [s] / (1 μs) or 5 000 whichever is greater



Reference No.: WTX24X09214732W001

- Trigger Mode: Video trigger

NOTE 1: In case video triggering is not possible, an external trigger source may be used.

- Sweep Time: > 120 % of the duration of the longest burst detected during the measurement of the RF Output Power

**Step 2:** (segment 2 483.5 MHz to 2 483.5 MHz + BW)

- Adjust the trigger level to select the transmissions with the highest power level.
- For frequency hopping equipment operating in a normal hopping mode, the different hops will result in signal bursts with different power levels. In this case the burst with the highest power level shall be selected.
- Set a window (start and stop lines) to match with the start and end of the burst and in which the RMS power shall be measured using the Time Domain Power function.
- Select RMS power to be measured within the selected window and note the result which is the RMS power within this 1 MHz segment (2483.5MHz to 2484.5MHz). Compare this value with the applicable limit provided by the mask.
- Increase the centre frequency in steps of 1MHz and repeat this measurement for every 1MHz segment within the range 2483.5MHz to 2483.5MHz + BW. The centre frequency of the last 1MHz segment shall be set to 2483.5MHz + BW – 0.5MHz (which means this may partly overlap with the previous 1MHz segment).

**Step 3:** (segment 2483.5MHz + BW to 2483.5MHz + 2BW)

- Change the centre frequency of the analyser to 2 484 MHz + BW and perform the measurement for the first 1 MHz segment within range 2 483.5 MHz + BW to 2 483.5 MHz + 2BW. Increase the centre frequency in 1 MHz steps and repeat the measurements to cover this whole range. The centre frequency of the last 1 MHz segment shall be set to 2483.5MHz + 2 BW – 0.5MHz.

**Step 4:** (segment 2400MHz - BW to 2400MHz)

- Change the centre frequency of the analyser to 2399.5MHz and perform the measurement for the first 1MHz segment within range 2400MHz - BW to 2400MHz Reduce the centre frequency in 1MHz steps and repeat the measurements to cover this whole range. The centre frequency of the last 1 MHz segment shall be set to 2400MHz - 2BW + 0.5MHz.

**Step 5:** (segment 2400MHz - 2BW to 2400MHz - BW)

- Change the centre frequency of the analyser to 2 399.5MHz - BW and perform the measurement for the first 1 MHz segment within range 2400MHz - 2BW to 2400MHz - BW. Reduce the centre frequency in 1MHz steps and repeat the measurements to cover this whole range. The centre frequency of the last 1MHz segment shall be set to 2400MHz - 2BW + 0.5MHz.

**Step 6:**

- In case of conducted measurements on equipment with a single transmit chain, the declared antenna assembly gain "G" in dBi shall be added to the results for each of the 1MHz segments and compared with the limits provided by the mask given in figure 1 or figure 3. If more than one antenna assembly is intended for this power setting, the antenna with the highest gain shall be considered.
- In case of conducted measurements on smart antenna systems (equipment with multiple transmit chains), the measurements need to be repeated for each of the active transmit chains. The declared antenna



Reference No.: WTX24X09214732W001

assembly gain "G" in dBi for a single antenna shall be added to these results. If more than one antenna assembly is intended for this power setting, the antenna with the highest gain shall be considered.

Comparison with the applicable limits shall be done using any of the options given below:

- Option 1: the results for each of the transmit chains for the corresponding 1 MHz segments shall be added. The additional beamforming gain "Y" in dB shall be added as well and the resulting values compared with the limits provided by the mask given in figure 1 or figure 3.

NOTE 2: A ch refers to the number of active transmit chains.

It shall be recorded whether the equipment complies with the mask provided in figure 1 or figure 3.

RBW=1MHz VBW=3MHz

### 6.3 Summary of Test Results/Plots

Please refer to Appendix D

# WALTEK



## 7. TRANSMITTER UNWANTED EMISSIONS IN THE SPURIOUS DOMAIN

### 7.1 Standard Applicable

According to section 4.3.1.10.3& 4.3.2.9.3, the transmitter unwanted emissions in the spurious domain shall not exceed the values given in the following table.

Transmitter limit for spurious emissions

Frequency range	Maximum power	Bandwidth
30MHz to 47MHz	-36dBm	100kHz
47MHz to 74MHz	-54dBm	100kHz
74MHz to 87.5MHz	-36dBm	100kHz
87.5MHz to 118MHz	-54dBm	100kHz
118MHz to 174MHz	-36dBm	100kHz
174MHz to 230MHz	-54dBm	100kHz
230MHz to 470MHz	-36dBm	100kHz
470MHz to 694MHz	-54dBm	100kHz
694MHz to 1GHz	-36dBm	100kHz
1GHz to 12.75GHz	-30dBm	1MHz

### 7.2 Test Procedure

The device under test has an integral antenna and the radiated measurement shall apply to the device, using the method of measurement as described in the EN300328 section 5.4.9.2

RBW=100kHz    VBW=300kHz    30MHz-1GHz  
 RBW=1MHz    VBW=3MHz    1GHz-12.75GHz

### 7.3 Summary of Test Results/Plots

According to the data, the EUT complied with the EN 300328 standards, and had the worst cases:



➤ Spurious Emission From 30MHz To 1GHz  
For BLE 1Mbps

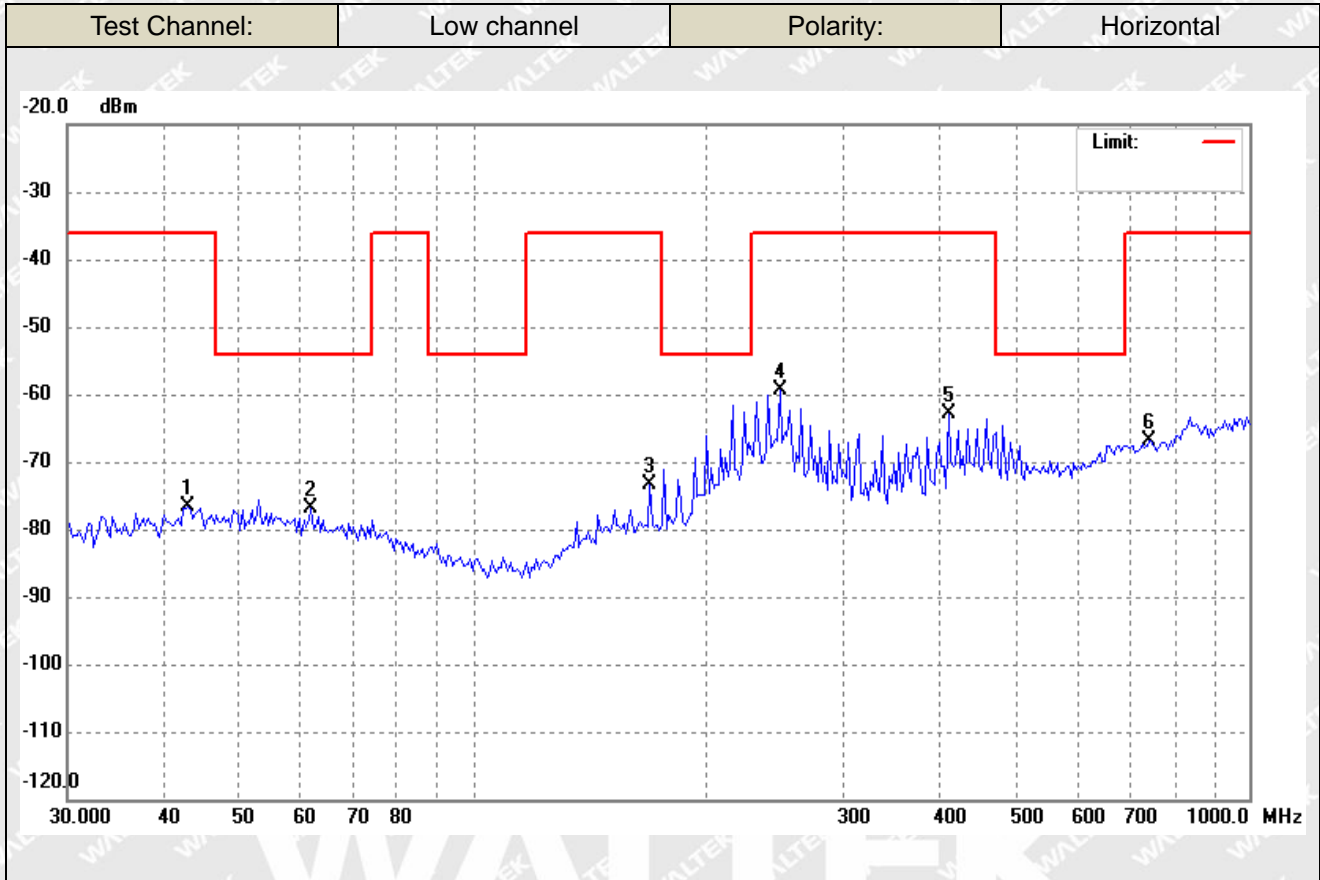

No.	Frequency (MHz)	Reading (dBm)	Correct Factor(dB)	Result (dBm)	Limit (dBm)	Margin (dB)	Remark
1	42.9305	-79.55	2.83	-76.72	-36.00	-40.72	ERP
2	61.8676	-79.02	2.06	-76.96	-54.00	-22.96	ERP
3	168.9970	-74.42	0.98	-73.44	-36.00	-37.44	ERP
4	248.7319	-67.64	8.33	-59.31	-36.00	-23.31	ERP
5	409.6506	-67.74	4.90	-62.84	-36.00	-26.84	ERP
6	744.4265	-78.00	11.16	-66.84	-36.00	-30.84	ERP

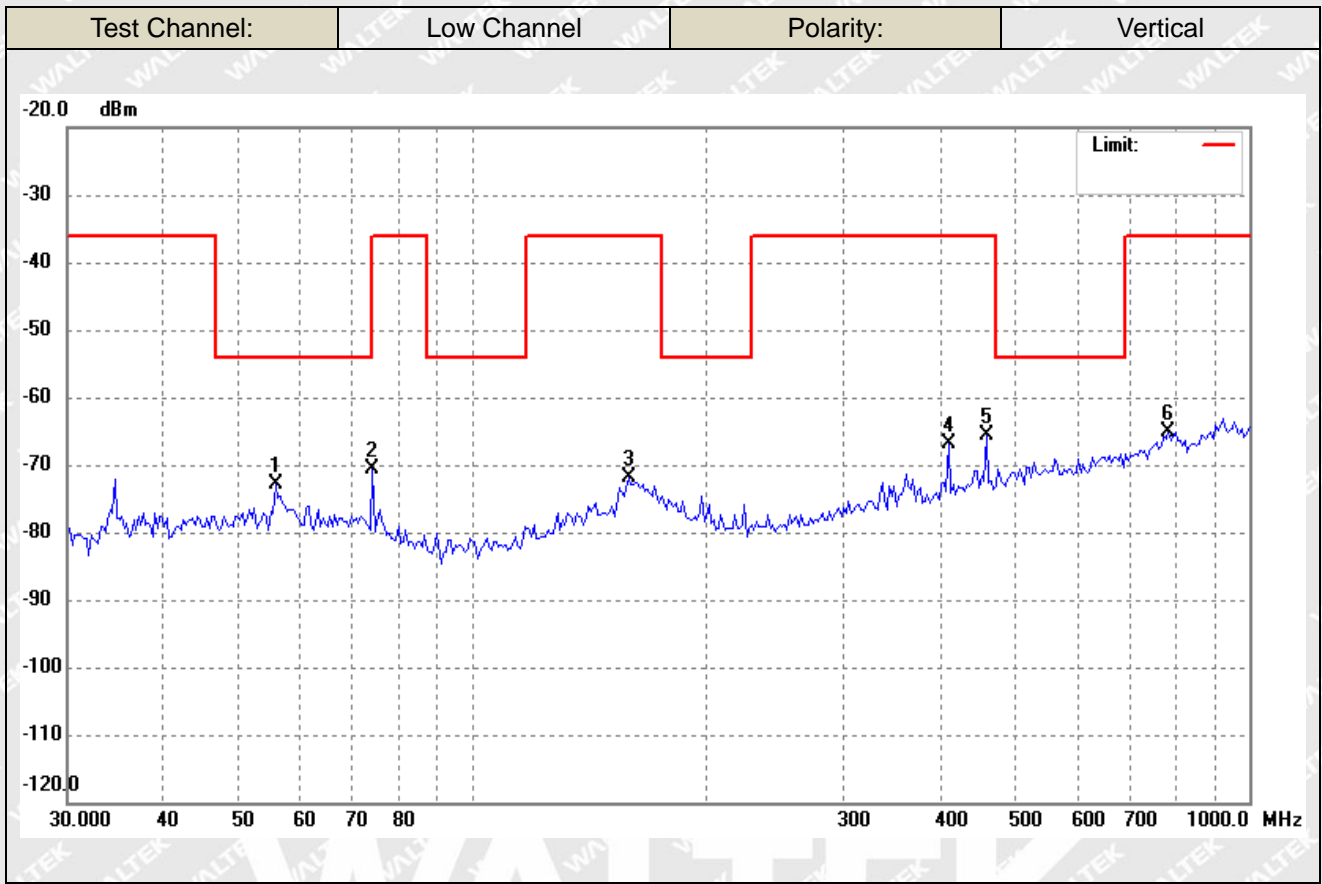

No.	Frequency (MHz)	Reading (dBm)	Correct Factor(dB)	Result (dBm)	Limit (dBm)	Margin (dB)	Remark
1	55.6782	-76.25	3.38	-72.87	-54.00	-18.87	ERP
2	74.2696	-72.54	1.94	-70.60	-36.00	-34.60	ERP
3	158.6399	-79.34	7.39	-71.95	-36.00	-35.95	ERP
4	409.6506	-72.43	5.54	-66.89	-36.00	-30.89	ERP
5	458.3987	-71.98	6.42	-65.56	-36.00	-29.56	ERP
6	787.4749	-77.43	12.34	-65.09	-36.00	-29.09	ERP

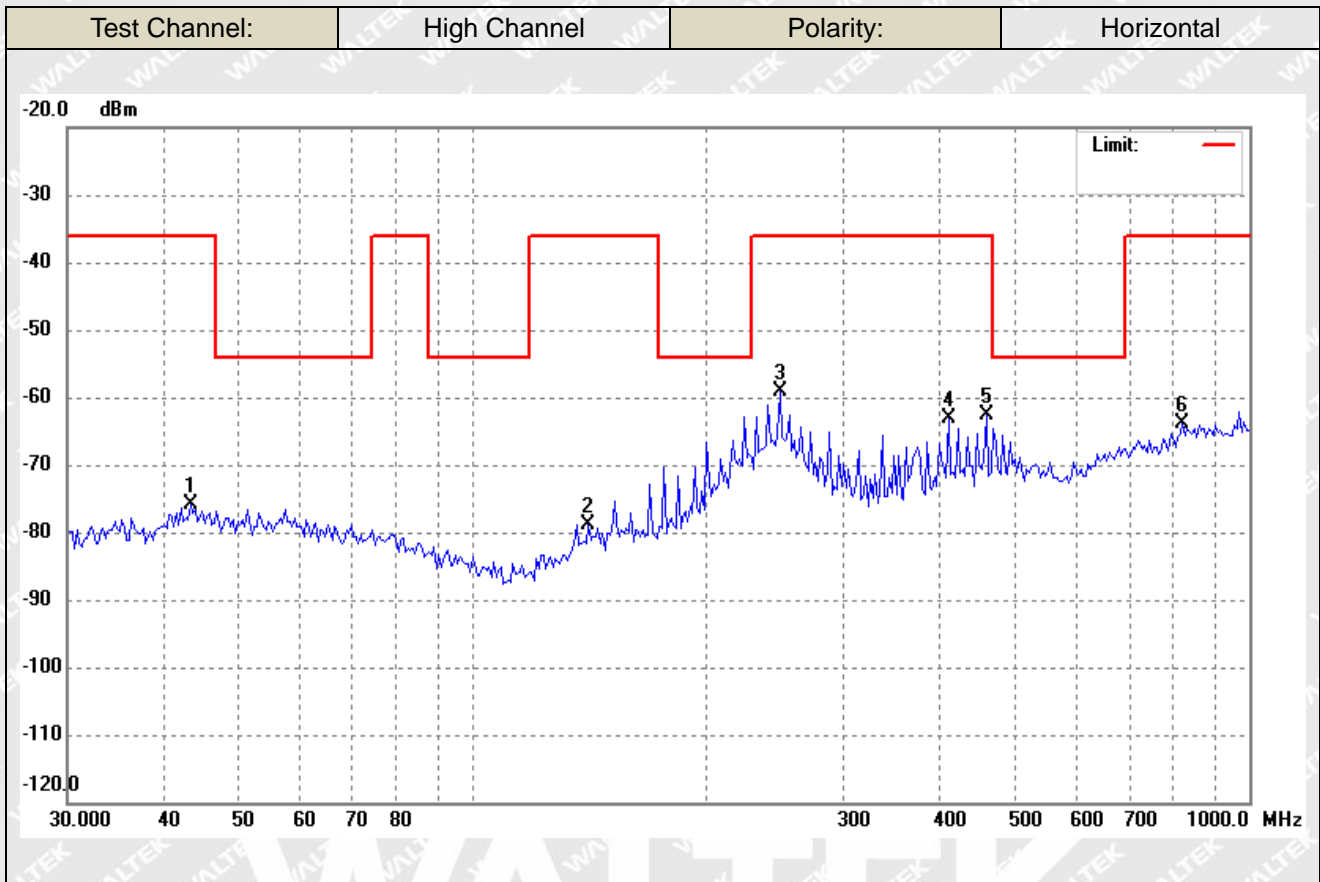

No.	Frequency (MHz)	Reading (dBm)	Correct Factor(dB)	Result (dBm)	Limit (dBm)	Margin (dB)	Remark
1	43.2333	-78.81	2.86	-75.95	-36.00	-39.95	ERP
2	140.7767	-78.55	-0.23	-78.78	-36.00	-42.78	ERP
3	248.7319	-67.37	8.33	-59.04	-36.00	-23.04	ERP
4	409.6506	-67.90	4.90	-63.00	-36.00	-27.00	ERP
5	458.3987	-68.88	6.19	-62.69	-36.00	-26.69	ERP
6	821.3871	-76.91	12.97	-63.94	-36.00	-27.94	ERP

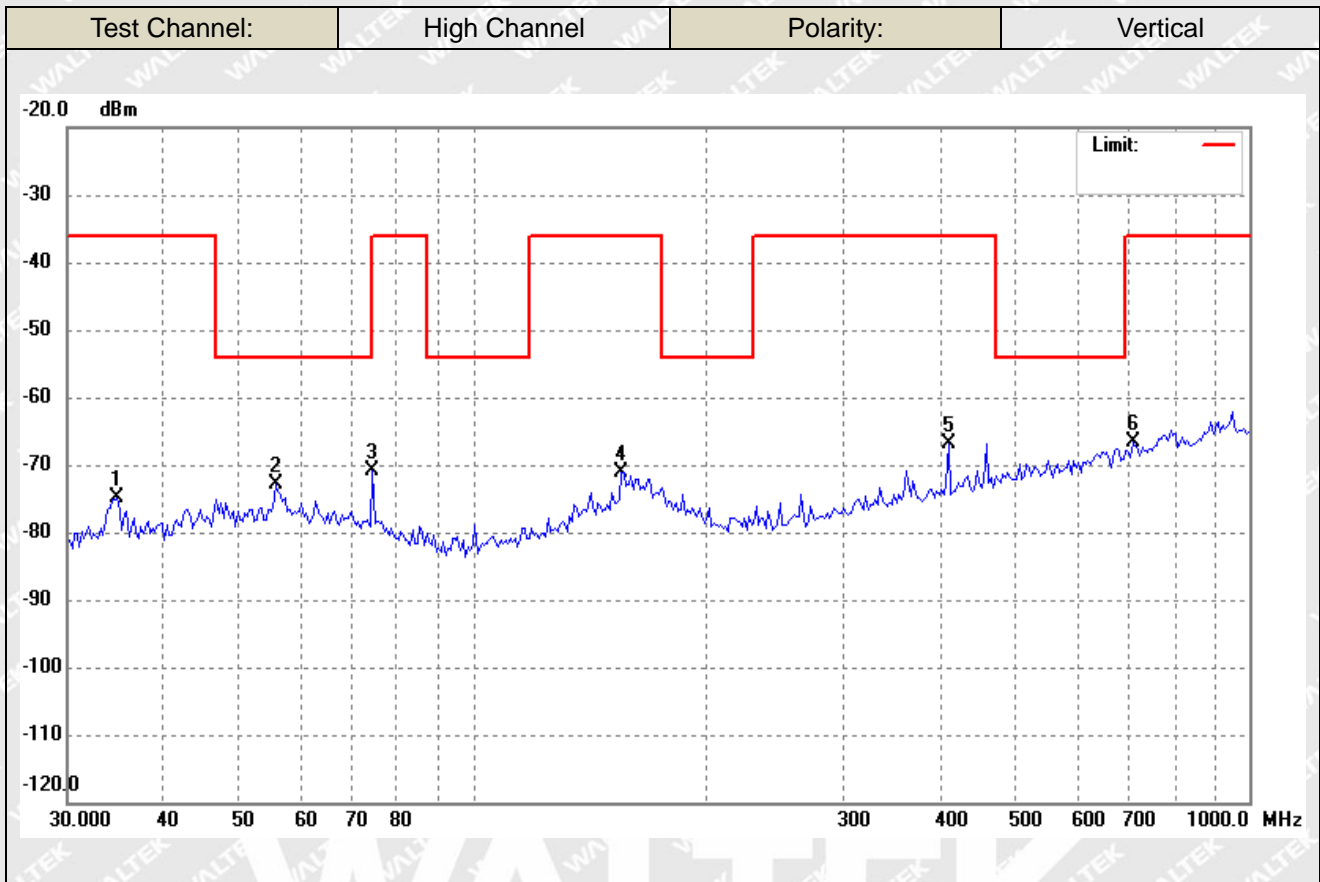

No.	Frequency (MHz)	Reading (dBm)	Correct Factor(dB)	Result (dBm)	Limit (dBm)	Margin (dB)	Remark
1	34.7705	-76.91	2.05	-74.86	-36.00	-38.86	ERP
2	55.6782	-76.23	3.38	-72.85	-54.00	-18.85	ERP
3	74.2696	-72.89	1.94	-70.95	-36.00	-34.95	ERP
4	155.3305	-77.29	6.09	-71.20	-36.00	-35.20	ERP
5	409.6506	-72.34	5.54	-66.80	-36.00	-30.80	ERP
6	708.6941	-77.00	10.31	-66.69	-36.00	-30.69	ERP





For BLE 2Mbps

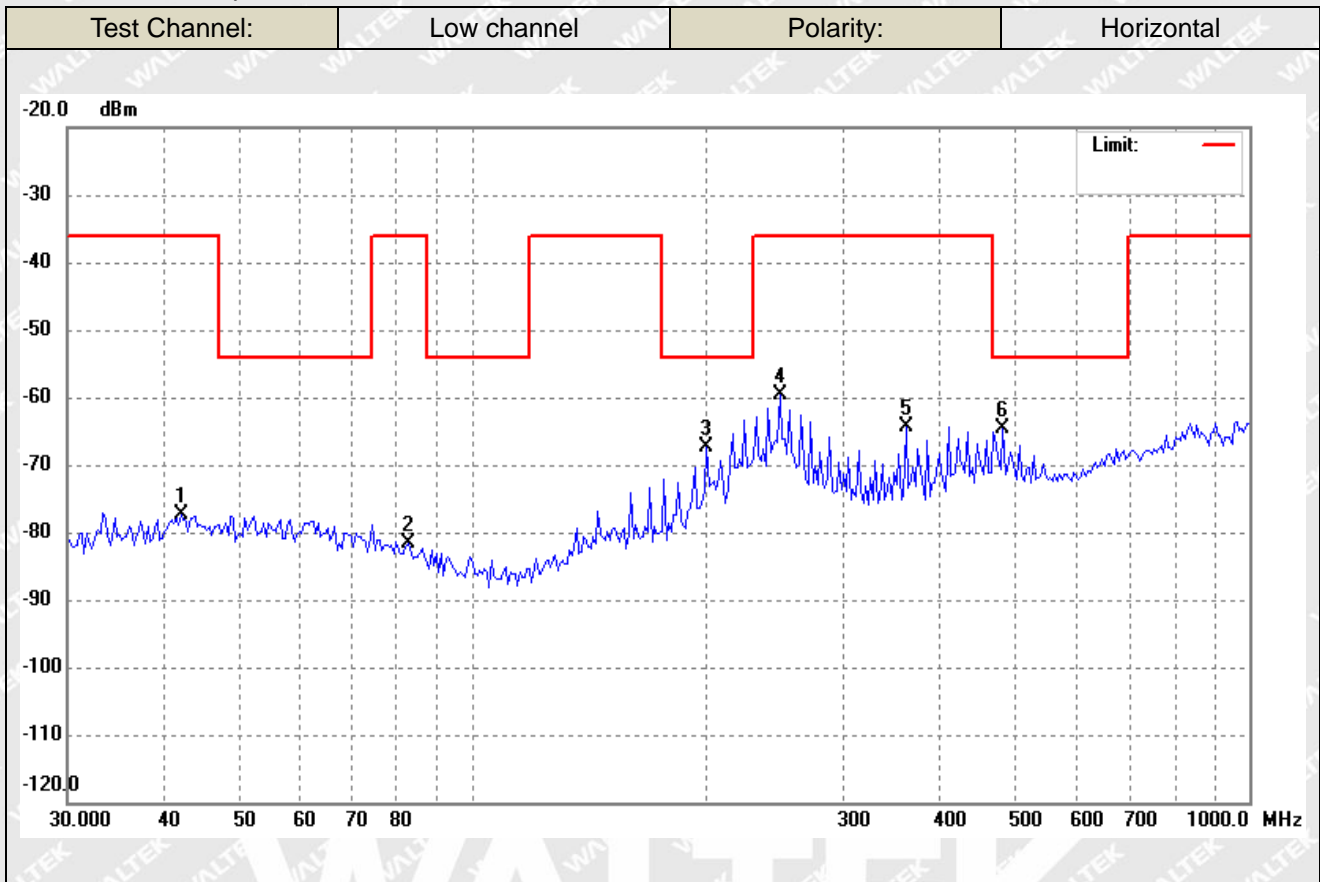

No.	Frequency (MHz)	Reading (dBm)	Correct Factor(dB)	Result (dBm)	Limit (dBm)	Margin (dB)	Remark
1	42.0350	-80.13	2.74	-77.39	-36.00	-41.39	ERP
2	82.5257	-80.60	-1.13	-81.73	-36.00	-45.73	ERP
3	200.0432	-67.38	-0.02	-67.40	-54.00	-13.40	ERP
4	248.7319	-68.03	8.33	-59.70	-36.00	-23.70	ERP
5	360.9775	-68.79	4.54	-64.25	-36.00	-28.25	ERP
6	481.5112	-71.52	6.80	-64.72	-54.00	-10.72	ERP

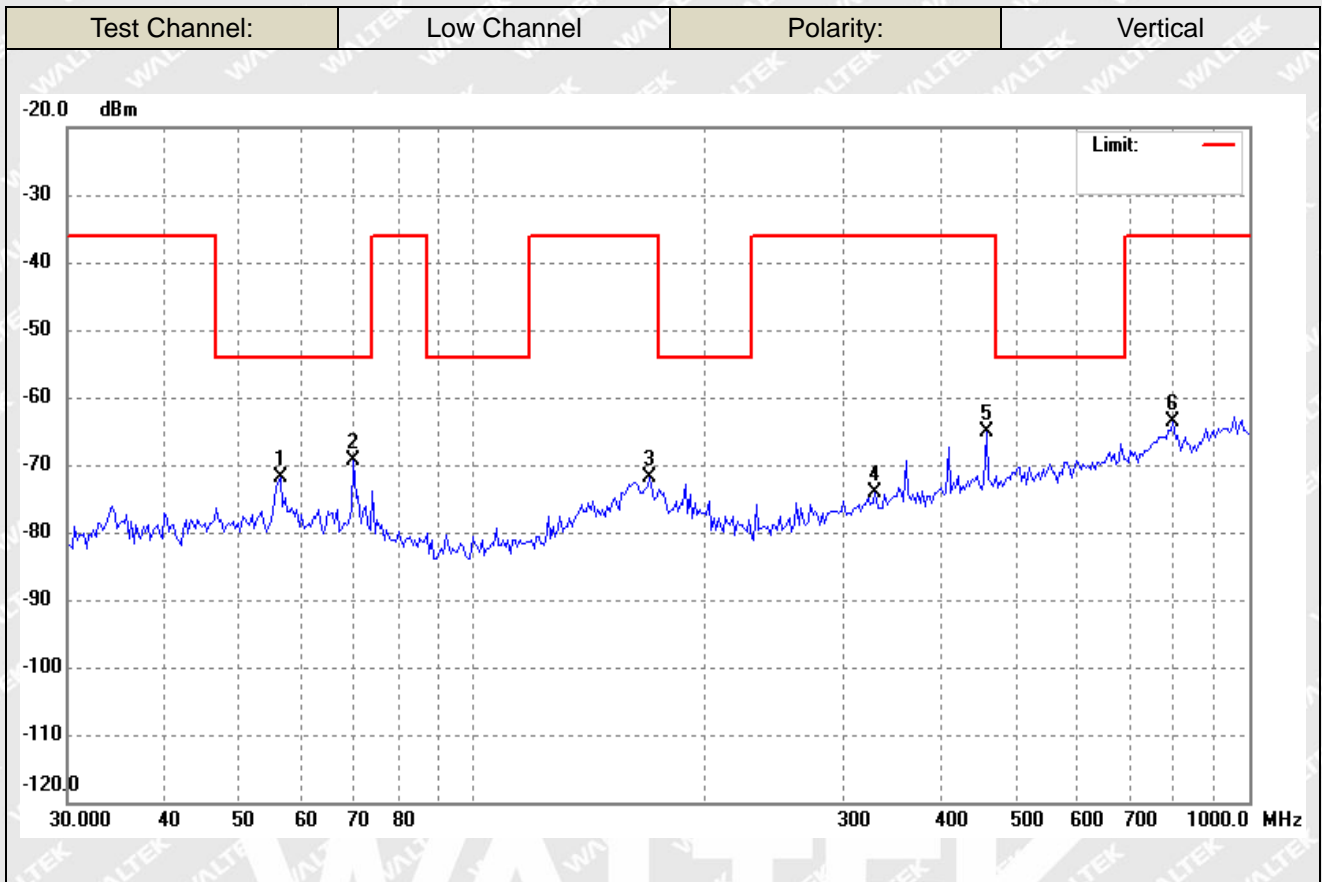

No.	Frequency (MHz)	Reading (dBm)	Correct Factor(dB)	Result (dBm)	Limit (dBm)	Margin (dB)	Remark
1	56.4662	-75.29	3.37	-71.92	-54.00	-17.92	ERP
2	70.2096	-72.44	3.03	-69.41	-54.00	-15.41	ERP
3	168.9970	-78.16	6.35	-71.81	-36.00	-35.81	ERP
4	329.4625	-78.02	3.92	-74.10	-36.00	-38.10	ERP
5	458.3987	-71.55	6.42	-65.13	-36.00	-29.13	ERP
6	798.6205	-76.27	12.62	-63.65	-36.00	-27.65	ERP

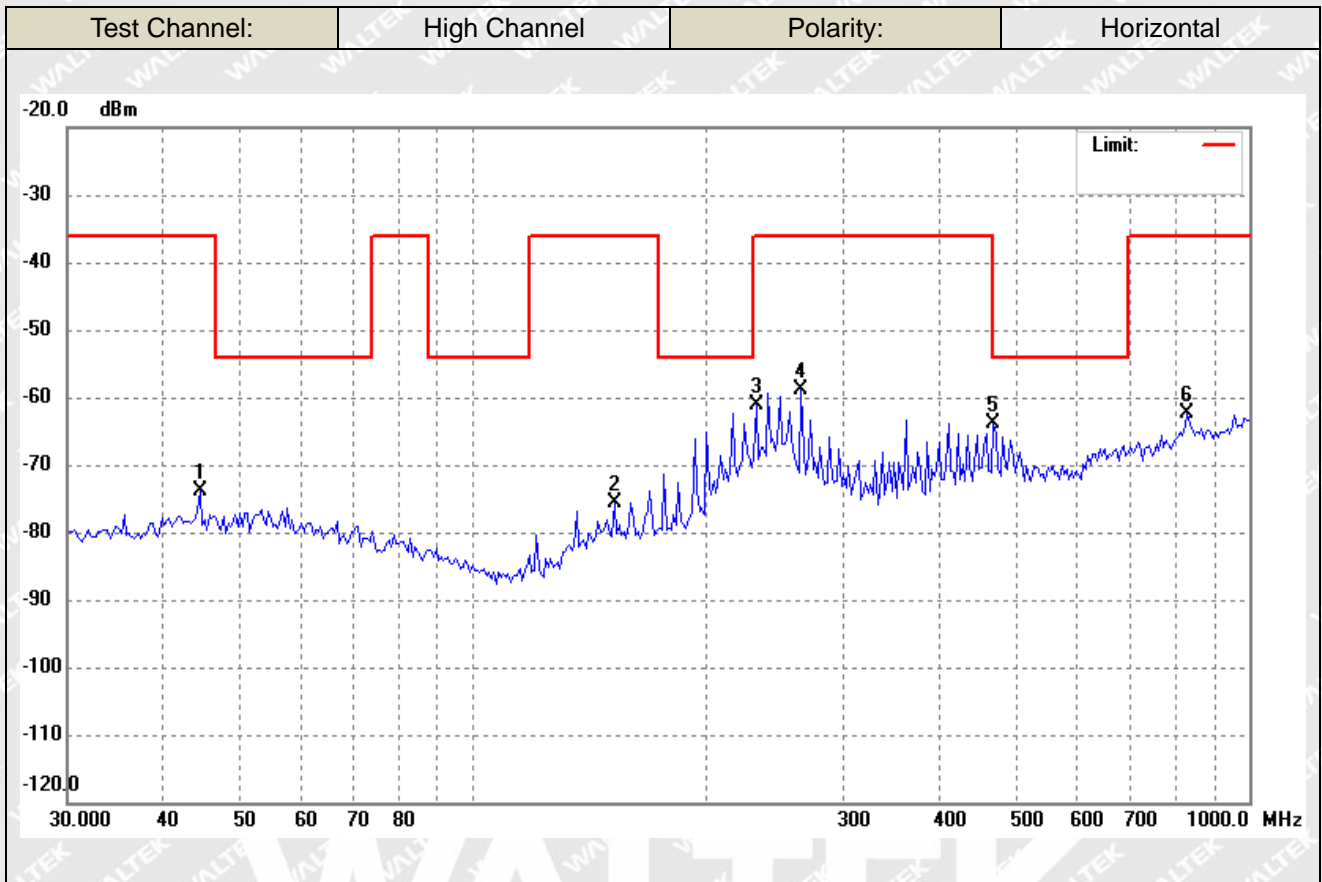

No.	Frequency (MHz)	Reading (dBm)	Correct Factor(dB)	Result (dBm)	Limit (dBm)	Margin (dB)	Remark
1	44.4657	-76.87	2.97	-73.90	-36.00	-37.90	ERP
2	152.0902	-76.48	0.90	-75.58	-36.00	-39.58	ERP
3	231.8531	-66.64	5.44	-61.20	-36.00	-25.20	ERP
4	264.9709	-66.27	7.30	-58.97	-36.00	-22.97	ERP
5	468.1651	-70.33	6.45	-63.88	-36.00	-27.88	ERP
6	833.0127	-75.82	13.37	-62.45	-36.00	-26.45	ERP

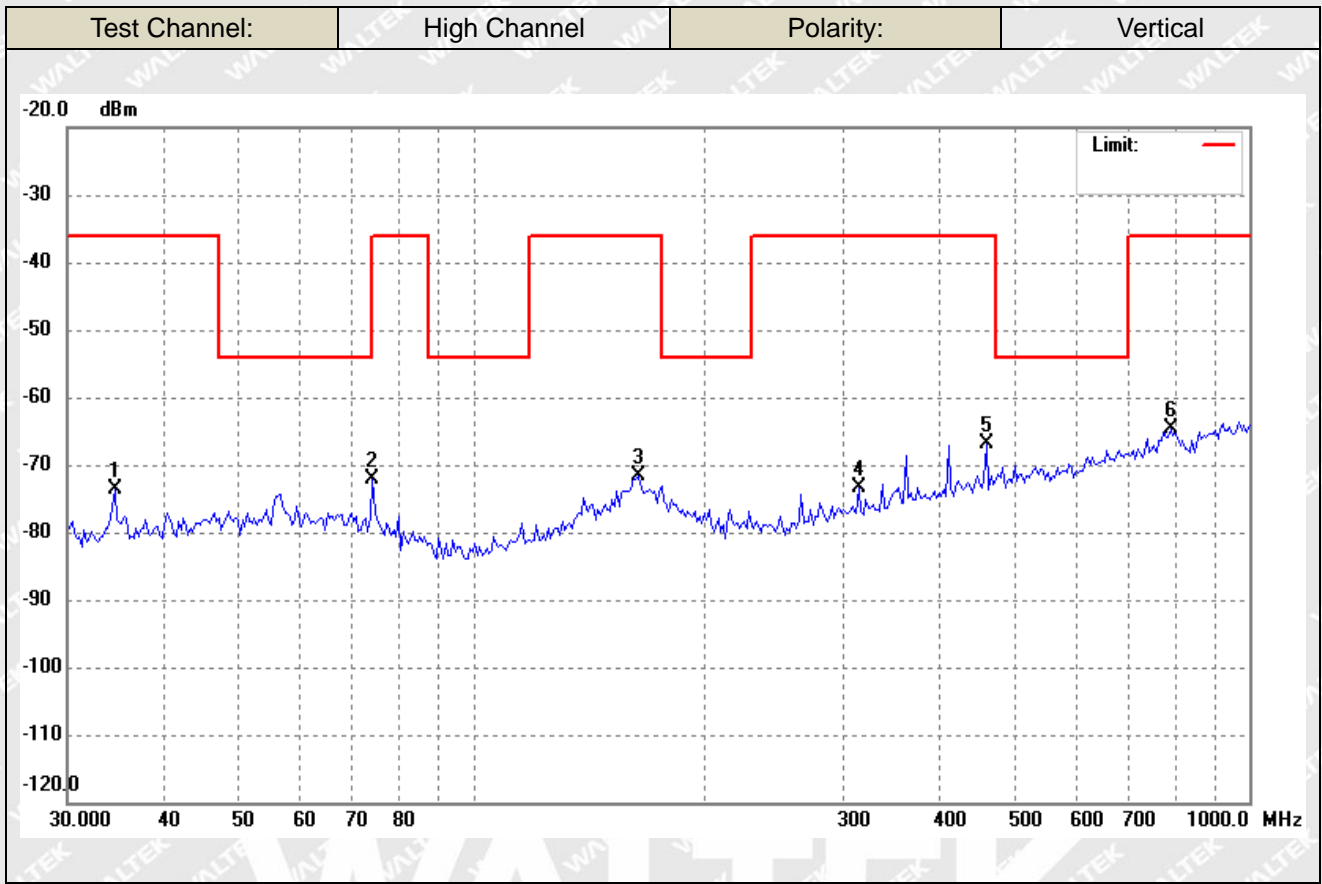

No.	Frequency (MHz)	Reading (dBm)	Correct Factor(dB)	Result (dBm)	Limit (dBm)	Margin (dB)	Remark
1	34.5270	-75.55	2.03	-73.52	-36.00	-37.52	ERP
2	74.2696	-74.04	1.94	-72.10	-36.00	-36.10	ERP
3	163.1623	-78.99	7.37	-71.62	-36.00	-35.62	ERP
4	313.6483	-76.94	3.59	-73.35	-36.00	-37.35	ERP
5	458.3987	-73.34	6.42	-66.92	-36.00	-30.92	ERP
6	793.0281	-77.07	12.48	-64.59	-36.00	-28.59	ERP



➤ Spurious Emission Above 1GHz

For BLE 1Mbps

Frequency (MHz)	Reading (dBm)	Correct dB	Result (dBm)	Limit (dBm)	Margin (dB)	Polar H/V
Low Channel-2402MHz						
4804	-40.16	0.62	-39.54	-30	-9.54	H
7206	-56.44	5.50	-50.94	-30	-20.94	H
4804	-41.04	0.62	-40.42	-30	-10.42	V
7206	-57.56	5.50	-52.06	-30	-22.06	V
High Channel-2480MHz						
4960	-40.45	0.08	-40.37	-30	-10.37	H
7440	-55.95	6.61	-49.34	-30	-19.34	H
4960	-41.00	0.08	-40.92	-30	-10.92	V
7440	-55.93	6.61	-49.32	-30	-19.32	V

For BLE 2Mbps

Frequency (MHz)	Reading (dBm)	Correct dB	Result (dBm)	Limit (dBm)	Margin (dB)	Polar H/V
Low Channel-2402MHz						
4804	-42.05	0.62	-41.43	-30	-11.43	H
7206	-56.04	5.50	-50.54	-30	-20.54	H
4804	-41.64	0.62	-41.02	-30	-11.02	V
7206	-58.43	5.50	-52.93	-30	-22.93	V
High Channel-2480MHz						
4960	-40.93	0.08	-40.85	-30	-10.85	H
7440	-56.52	6.61	-49.91	-30	-19.91	H
4960	-42.22	0.08	-42.14	-30	-12.14	V
7440	-57.30	6.61	-50.69	-30	-20.69	V

Note 1: Testing is carried out with frequency rang 30MHz to 12.75GHz, which above 4<sup>th</sup> Harmonics are attenuated more than 20dB below the permissible limits or the field strength is too small to be measured.

Note 2: this EUT was tested in 3 orthogonal positions and the worst case position data was reported.

➤ **Conducted Transmitter Spurious Emission:**

**Please refer to Appendix E**



## 8. RECEIVER SPURIOUS EMISSIONS

### 8.1 Standard Applicable

According to section 4.3.1.11.3&4.3.2.10.3, the spurious emissions of the receiver shall not exceed the values given in table below:

NOTE: In case of equipment with antenna connectors, these limits apply to emissions at the antenna port (conducted) and to the emissions radiated by the cabinet. In case of integral antenna equipment (without temporary antenna connectors), these limits apply to emissions radiated by the equipment. Spurious emission limits for receivers

Frequency range	Maximum power	Bandwidth
30MHz to 1GHz	-57dBm	100kHz
1GHz to 12.75GHz	-47dBm	1MHz

### 8.2 Test Procedure

The device under test has an integral antenna and the radiated measurement shall apply to the device, using the method of measurement as described in the EN300328 section 5.4.10.2.

RBW=100kHz    VBW=300kHz    30MHz-1GHz

RBW=1MHz    VBW=3MHz    1GHz-12.75GHz

### 8.3 Summary of Test Results/Plots

According to the data, the EUT complied with the EN 300328 standards, and had the worst case:



➤ Receiver Spurious Emission From 30MHz To 1GHz

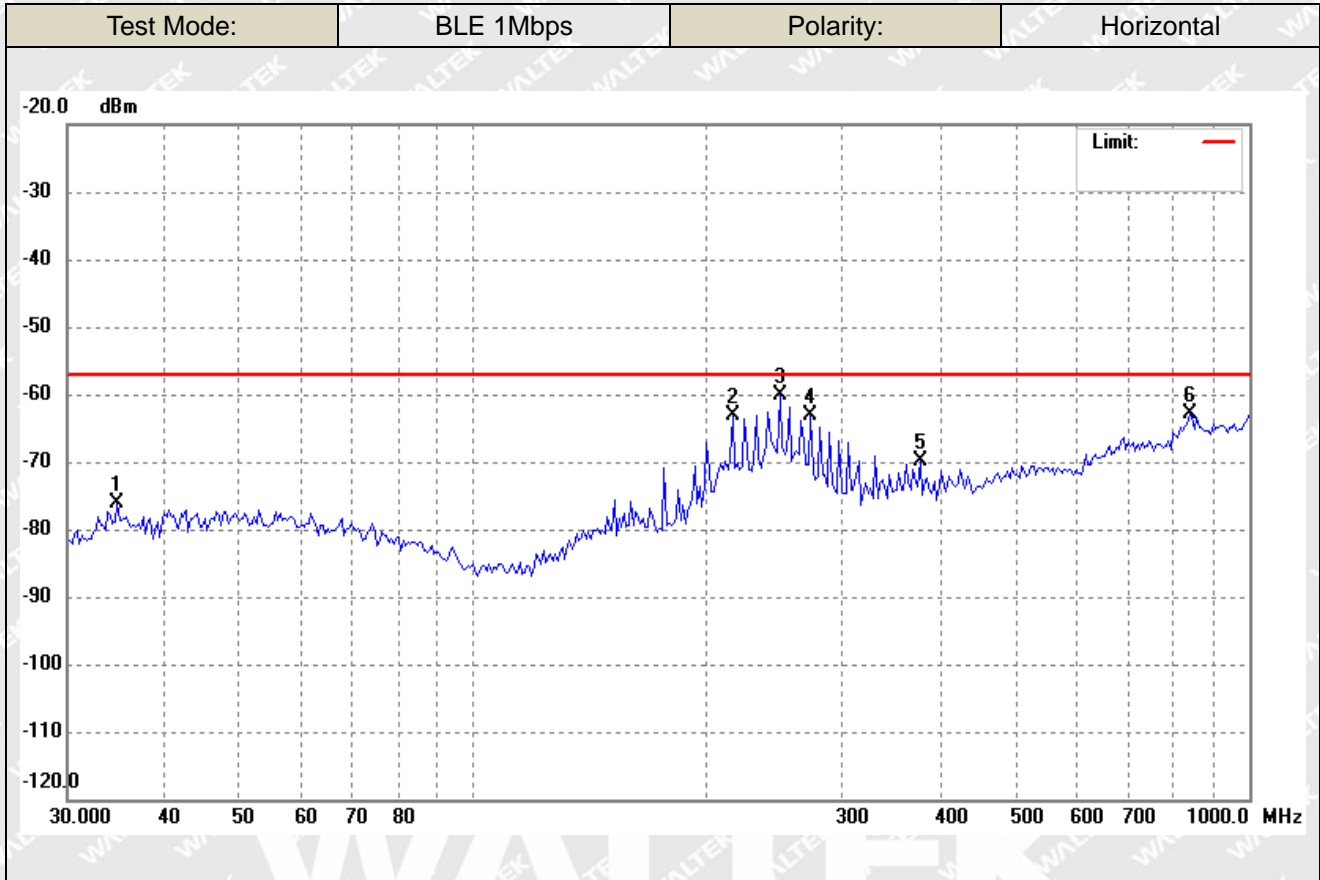

No.	Frequency (MHz)	Reading (dBm)	Correct Factor(dB)	Result (dBm)	Limit (dBm)	Margin (dB)	Remark
1	34.7705	-78.13	2.05	-76.08	-57.00	-19.08	ERP
2	216.1197	-65.84	2.74	-63.10	-57.00	-6.10	ERP
3	248.7319	-68.57	8.33	-60.24	-57.00	-3.24	ERP
4	272.5246	-69.70	6.68	-63.02	-57.00	-6.02	ERP
5	376.5228	-74.42	4.58	-69.84	-57.00	-12.84	ERP
6	838.8870	-76.48	13.50	-62.98	-57.00	-5.98	ERP

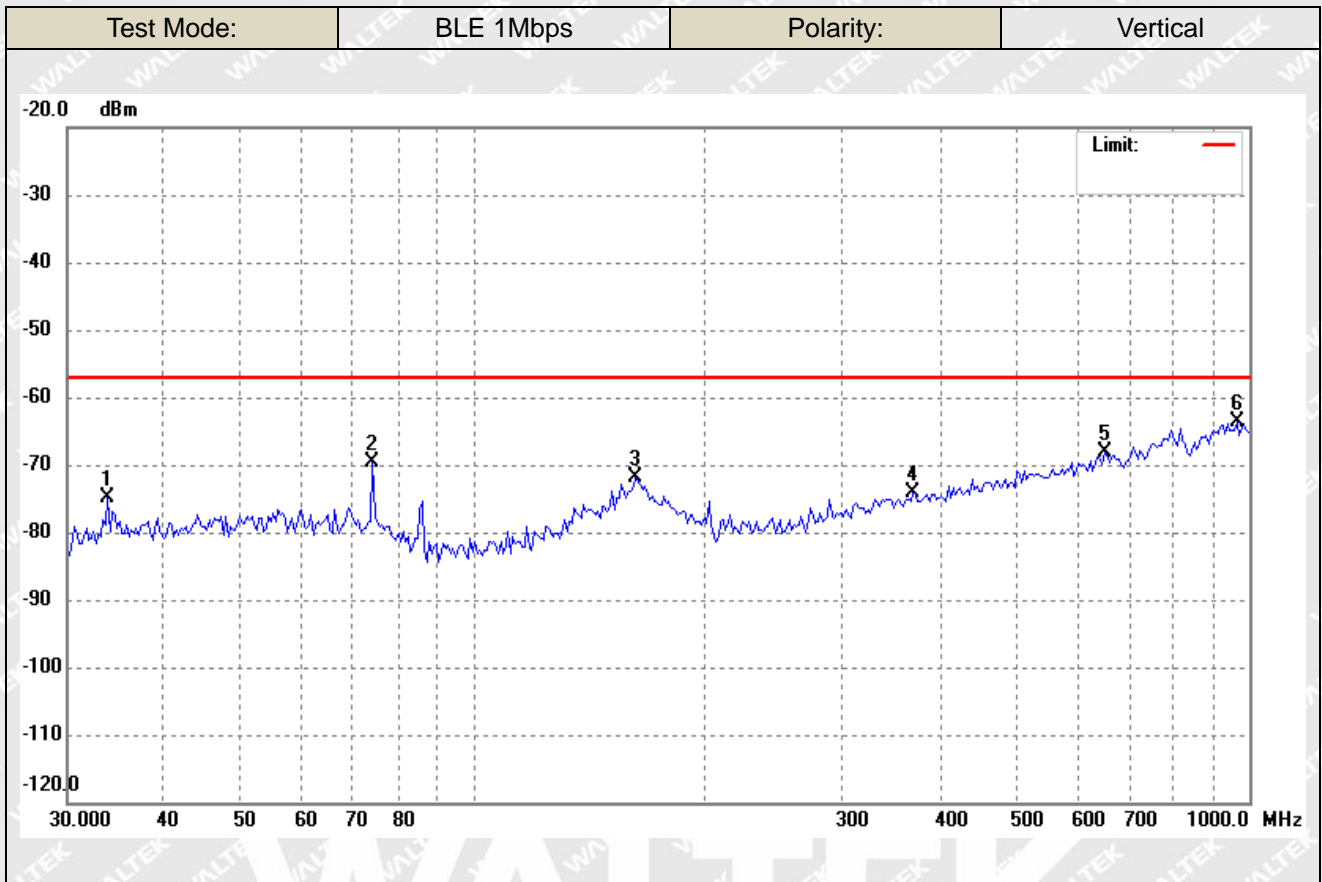

No.	Frequency (MHz)	Reading (dBm)	Correct Factor(dB)	Result (dBm)	Limit (dBm)	Margin (dB)	Remark
1	33.8067	-76.82	1.96	-74.86	-57.00	-17.86	ERP
2	74.2696	-71.65	1.94	-69.71	-57.00	-12.71	ERP
3	162.0197	-79.56	7.57	-71.99	-57.00	-14.99	ERP
4	368.6682	-78.85	4.72	-74.13	-57.00	-17.13	ERP
5	651.3831	-77.64	9.48	-68.16	-57.00	-11.16	ERP
6	965.4742	-76.48	12.75	-63.73	-57.00	-6.73	ERP



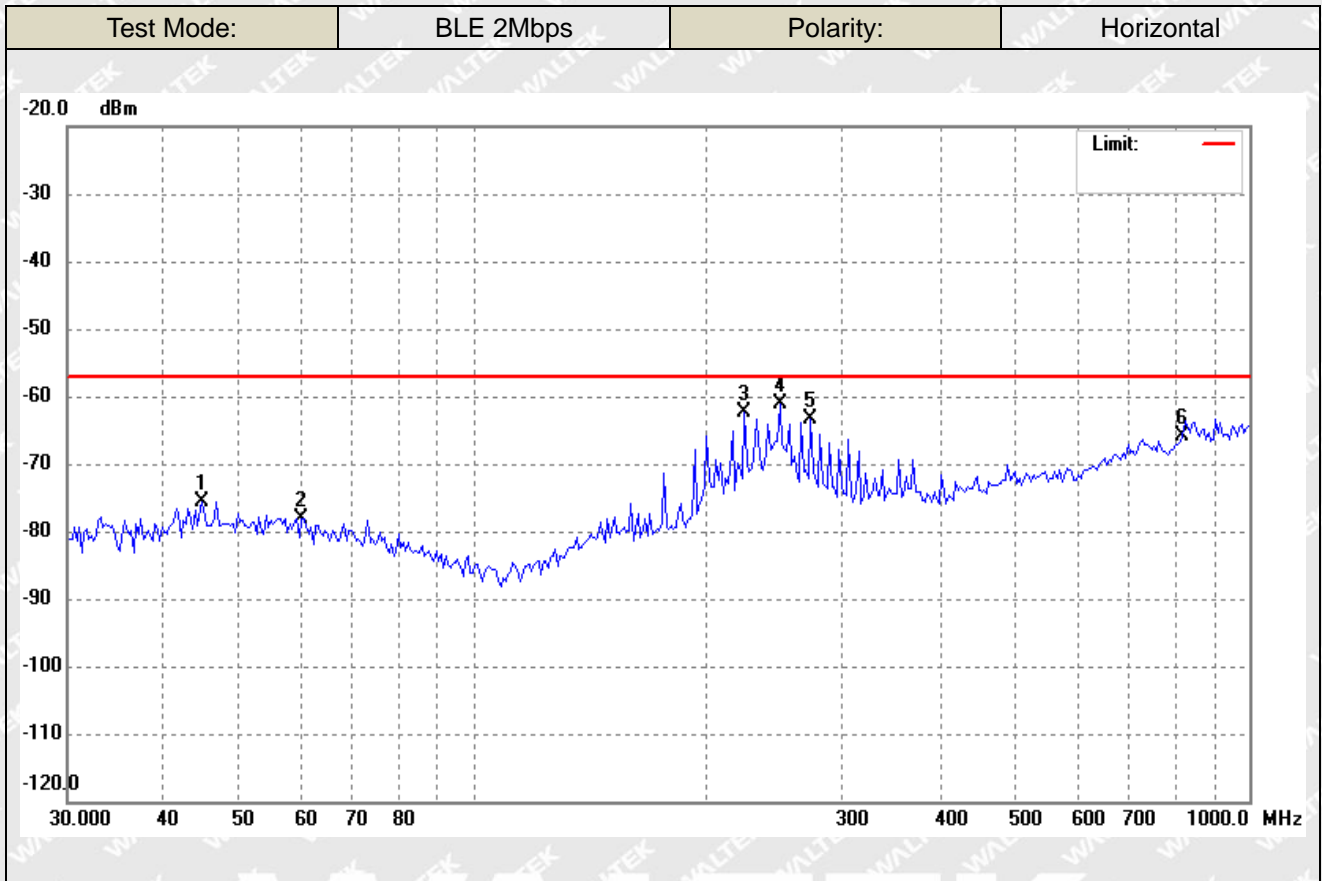

No.	Frequency (MHz)	Reading (dBm)	Correct Factor(dB)	Result (dBm)	Limit (dBm)	Margin (dB)	Remark
1	44.7793	-78.60	3.00	-75.60	-57.00	-18.60	ERP
2	60.5769	-80.45	2.21	-78.24	-57.00	-21.24	ERP
3	223.8482	-66.31	4.06	-62.25	-57.00	-5.25	ERP
4	248.7319	-69.34	8.33	-61.01	-57.00	-4.01	ERP
5	272.5246	-69.95	6.68	-63.27	-57.00	-6.27	ERP
6	821.3871	-78.84	12.97	-65.87	-57.00	-8.87	ERP

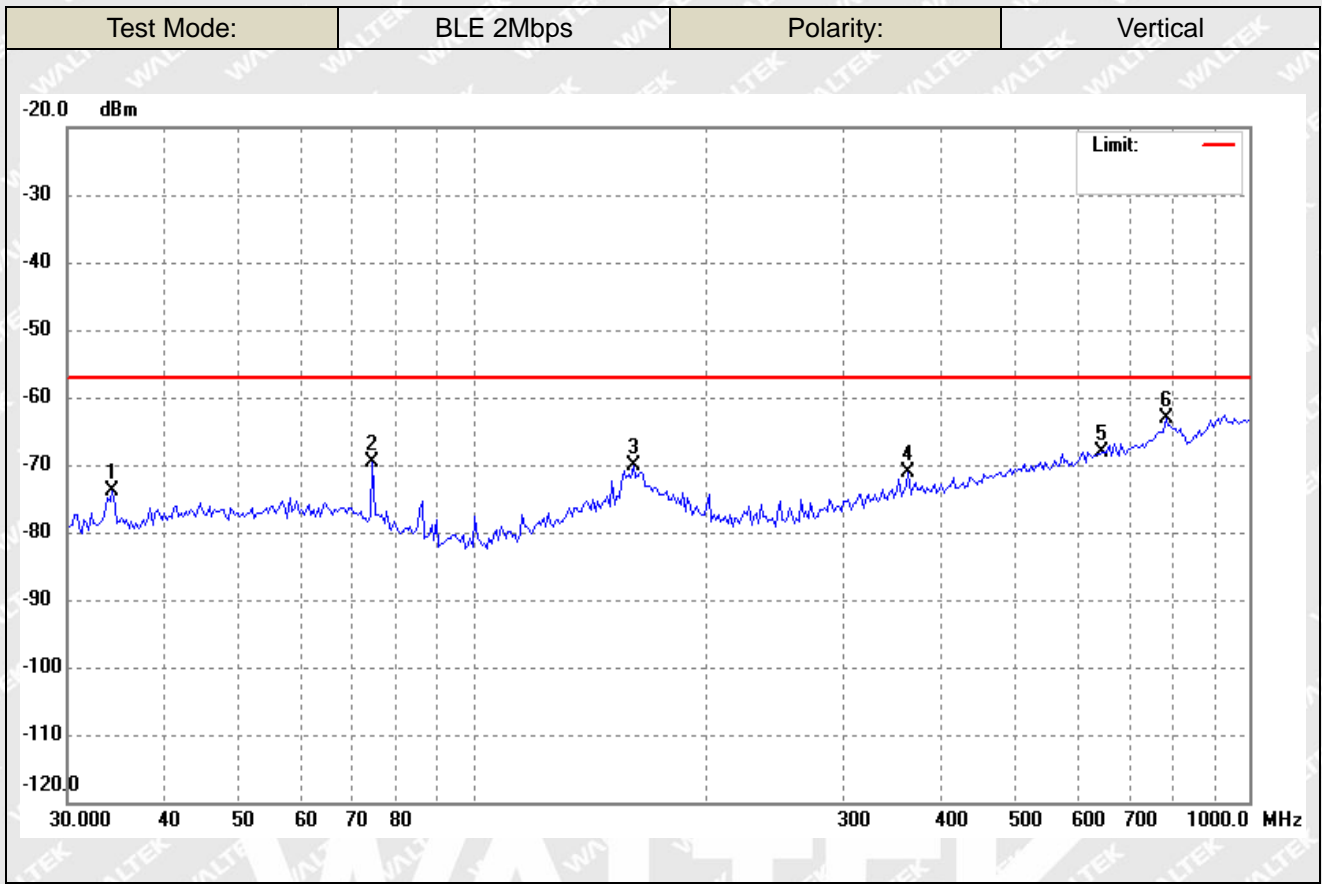

No.	Frequency (MHz)	Reading (dBm)	Correct Factor(dB)	Result (dBm)	Limit (dBm)	Margin (dB)	Remark
1	34.2852	-75.91	2.01	-73.90	-57.00	-16.90	ERP
2	74.2696	-71.61	1.94	-69.67	-57.00	-12.67	ERP
3	160.8852	-77.84	7.77	-70.07	-57.00	-13.07	ERP
4	363.5231	-75.69	4.62	-71.07	-57.00	-14.07	ERP
5	646.8217	-77.43	9.42	-68.01	-57.00	-11.01	ERP
6	781.9606	-75.41	12.20	-63.21	-57.00	-6.21	ERP



➤ Receiver Spurious Emission Above 1GHz

BLE 1Mbps Mode

Frequency (MHz)	Result (dBm)	Limit (dBm)	Margin (dB)	Polar H/V
1714.09	-62.37	-47	-15.37	H
6911.27	-58.15	-47	-11.15	H
4351.77	-56.07	-47	-9.07	V
7765.75	-53.70	-47	-6.70	V

BLE 2Mbps Mode

Frequency (MHz)	Result (dBm)	Limit (dBm)	Margin (dB)	Polar H/V
1703.18	-61.11	-47	-14.11	H
6902.49	-56.36	-47	-9.36	H
4360.54	-60.45	-47	-13.45	V
7784.03	-55.57	-47	-8.57	V

Note: Testing is carried out with frequency rang 30MHz to 12.75GHz, which above 1GHz are attenuated more than 20dB below the permissible limits or the field strength is too small to be measured.

**Conducted Receiver Spurious Emission:**

Please refer to Appendix F



## 9. RECEIVER BLOCKING

---

### 9.1 Standard Application

Receiver blocking is a measure of the ability of the equipment to receive a wanted signal on its operating channel without exceeding a given degradation due to the presence of an unwanted input signal (blocking signal) on frequencies other than those of the operating band and spurious responses.

#### Performance Criteria

For equipment that supports a PER or FER test to be performed, the minimum performance criterion shall be a PER or FER less than or equal to 10 %.

For equipment that does not support a PER or a FER test to be performed, the minimum performance criterion shall be no loss of the wireless transmission function needed for the intended use of the equipment.

The minimum performance criterion shall be a PER less than or equal to 10 %. The manufacturer may declare alternative performance criteria as long as that is appropriate for the intended use of the equipment (see clause 5.4.1.t)).

While maintaining the minimum performance criteria as defined in clause 4.3.1.12.3, the blocking levels at specified frequency offsets shall be equal to or greater than the limits defined for the applicable receiver category provided in table 6, table 7 or table 8.

#### Receiver category 1

Adaptive equipment with a maximum RF output power greater than 10 dBm e.i.r.p. shall be considered as receiver category 1 equipment.

#### Receiver category 2

non-adaptive equipment with a Medium Utilization (MU) factor greater than 1 % and less than or equal to 10 % (irrespective of the maximum RF output power); or equipment (adaptive or non-adaptive) with a maximum RF output power greater than 0 dBm e.i.r.p. and less than or equal to 10 dBm e.i.r.p.

#### Receiver category 3

non-adaptive equipment with a maximum Medium Utilization (MU) factor of 1 % (irrespective of the maximum RF output power); or equipment (adaptive or non-adaptive) with a maximum RF output power of 0 dBm e.i.r.p.



Table 6: Receiver Blocking parameters for Receiver Category 1 equipment

Wanted signal mean power from companion device (dBm) (see notes 1 and 4)	Blocking signal frequency (MHz)	Blocking signal power (dBm) (see note 4)	Type of blocking signal
(-133 dBm + 10 × log <sub>10</sub> (OCBW)) or -68 dBm whichever is less (see note 2)	2380 2504	-34	CW
(-139 dBm + 10 × log <sub>10</sub> (OCBW)) or -74 dBm whichever is less (see note 3)	2300 2330 2360 2524 2584 2674		

NOTE 1: OCBW is in Hz.

NOTE 2: In case of radiated measurements using a companion device and the level of the wanted signal from the companion device cannot be determined, a relative test may be performed using a wanted signal up to  $P_{\min} + 26$  dB where  $P_{\min}$  is the minimum level of wanted signal required to meet the minimum performance criteria as defined in clause 4.3.1.12.3 in the absence of any blocking signal.

NOTE 3: In case of radiated measurements using a companion device and the level of the wanted signal from the companion device cannot be determined, a relative test may be performed using a wanted signal up to  $P_{\min} + 20$  dB where  $P_{\min}$  is the minimum level of wanted signal required to meet the minimum performance criteria as defined in clause 4.3.1.12.3 in the absence of any blocking signal.

NOTE 4: The level specified is the level at the UUT receiver input assuming a 0 dBi antenna assembly gain. In case of conducted measurements, this level has to be corrected for the (in-band) antenna assembly gain (G). In case of radiated measurements, this level is equivalent to a power flux density (PFD) in front of the UUT antenna with the UUT being configured/positioned as recorded in clause 5.4.3.2.2.



Table 7: Receiver Blocking parameters receiver category 2 equipment

Wanted signal mean power from companion device (dBm) (see notes 1 and 3)	Blocking signal frequency (MHz)	Blocking signal power (dBm) (see note 3)	Type of blocking signal
$(-139\text{dBm} + 10 \times \log_{10}(\text{OCBW}) + 10 \text{ dB})$ or $(-74\text{dBm} + 10\text{dB})$ whichever is less (see note 2)	2380 2504 2300 2584	-34	CW
NOTE 1: OCBW is in Hz.			
NOTE 2: In case of radiated measurements using a companion device and the level of the wanted signal from the companion device cannot be determined, a relative test may be performed using a wanted signal up to $P_{\min} + 26 \text{ dB}$ where $P_{\min}$ is the minimum level of wanted signal required to meet the minimum performance criteria as defined in clause 4.3.1.12.3 in the absence of any blocking signal.			
NOTE 3: The level specified is the level at the UUT receiver input assuming a 0 dBi antenna assembly gain. In case of conducted measurements, this level has to be corrected for the (in-band) antenna assembly gain (G). In case of radiated measurements, this level is equivalent to a power flux density (PFD) in front of the UUT antenna with the UUT being configured/positioned as recorded in clause 5.4.3.2.2.			

Table 8: Receiver Blocking parameters receiver category 3 equipment

Wanted signal mean power from companion device (dBm) (see notes 1 and 3)	Blocking signal frequency (MHz)	Blocking signal power (dBm) (see note 3)	Type of blocking signal
$(-139\text{dBm} + 10 \times \log_{10}(\text{OCBW}) + 20 \text{ dB})$ or $(-74\text{dBm} + 20 \text{ dB})$ whichever is less (see note 2)	2380 2504 2300 2584	-34	CW
NOTE 1: OCBW is in Hz.			
NOTE 2: In case of radiated measurements using a companion device and the level of the wanted signal from the companion device cannot be determined, a relative test may be performed using a wanted signal up to $P_{\min} + 26 \text{ dB}$ where $P_{\min}$ is the minimum level of wanted signal required to meet the minimum performance criteria as defined in clause 4.3.1.12.3 in the absence of any blocking signal.			
NOTE 3: The level specified is the level at the UUT receiver input assuming a 0 dBi antenna assembly gain. In case of conducted measurements, this level has to be corrected for the (in-band) antenna assembly gain (G). In case of radiated measurements, this level is equivalent to a power flux density (PFD) in front of the UUT antenna with the UUT being configured/positioned as recorded in clause 5.4.3.2.2.			



## 9.2 Test Procedure

Step 1: • For non-frequency hopping equipment, the UUT shall be set to the lowest operating channel.

Step 2: • The blocking signal generator is set to the first frequency as defined in the appropriate table corresponding to the receiver category and type of equipment.

Step 3: • With the blocking signal generator switched off, a communication link is established between the UUT and the associated companion device using the test setup shown in figure 6. The variable attenuator is set to a value that achieves the minimum performance criteria as specified in clause 4.3.1.12.3 or clause 4.3.2.11.3 with a resolution of at least 1 dB. The resulting level for the wanted signal at the input of the UUT is  $P_{min}$ . This value shall be measured and recorded in the test report.

• The signal level is increased by the value provided in the table corresponding to the receiver category and type of equipment.

Step 4: • The blocking signal at the UUT is set to the level provided in the table corresponding to the receiver category and type of equipment. It shall be verified and recorded in the test report that the performance criteria as specified in clause 4.3.1.12.3 or clause 4.3.2.11.3 is met.

Step 5: • Repeat step 4 for each remaining combination of frequency and level for the blocking signal as provided in the table corresponding to the receiver category and type of equipment.

Step 6: • For non-frequency hopping equipment, repeat step 2 to step 5 with the UUT operating at the highest operating channel.

## 9.3 Test Setup

According to the section 5.4.11.2.1, the test block diagram shall be used.

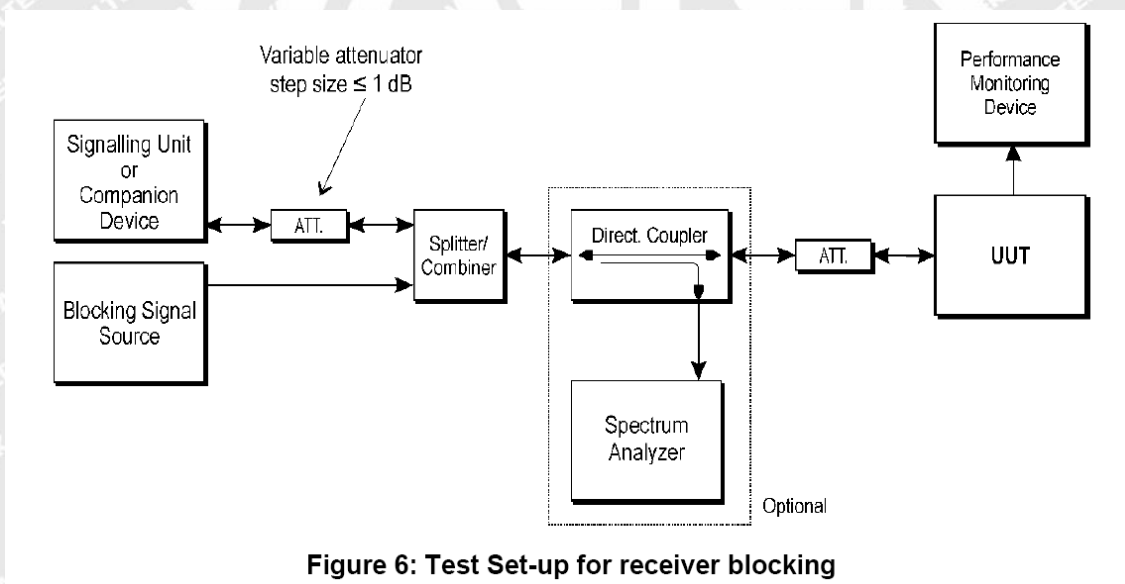

Figure 6: Test Set-up for receiver blocking

All test procedure is carried to the section 5.4.11.2.1

RBW/VBW=8MHz/30MHz



## 9.4 Summary of Test Results/Plots

The product is receiver category 2

Mode/ Channel	Wanted signal power (dBm)	Blocking signal Frequency (MHz)	Blocking signal power (dBm)	Test PER(%)	Limit(%)	Result
BLE 1Mbps- Low channel	-65.29	2380	-30.50	0	<10	Pass
		2504				
		2300				
		2584				
BLE 1Mbps- High channel	-65.22	2380	-30.50	0	<10	Pass
		2504				
		2300				
		2584				
BLE 2Mbps- Low channel	-62.39	2380	-30.50	0	<10	Pass
		2504				
		2300				
		2584				
BLE 2Mbps- High channel	-62.37	2380	-30.50	0	<10	Pass
		2504				
		2300				
		2584				

\*communication link is established between the UUT and the associated companion device using the test setup shown in figure 6. While the Companion device (CMW500) adjust to a level which can obtain the minimum performance criteria PER 10%, This level define to Pmin

Remark: the smallest channel bandwidth shall be used together with the lowest data rate for this channel bandwidth. This mode of operation are aligned with the performance criteria defined in clause 4.3.1.12.3 or clause 4.3.2.11.3 as declared by the manufacturer (see clause 5.4.1.t)).





## EXHIBIT 1 - EUT PHOTOGRAPHS

---

Please refer to "ANNEX".

# WALTEK



## EXHIBIT 2 - Test setup photo

**Spurious Emission  
Test Setup  
(Below 1GHz)**

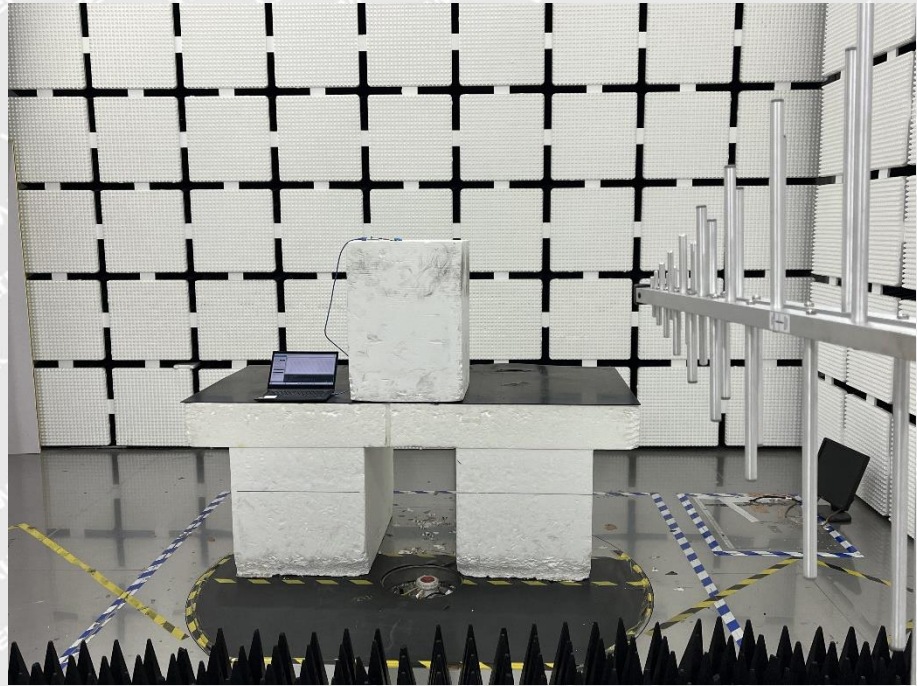

**Spurious Emission  
Test Setup (Above  
1GHz)**

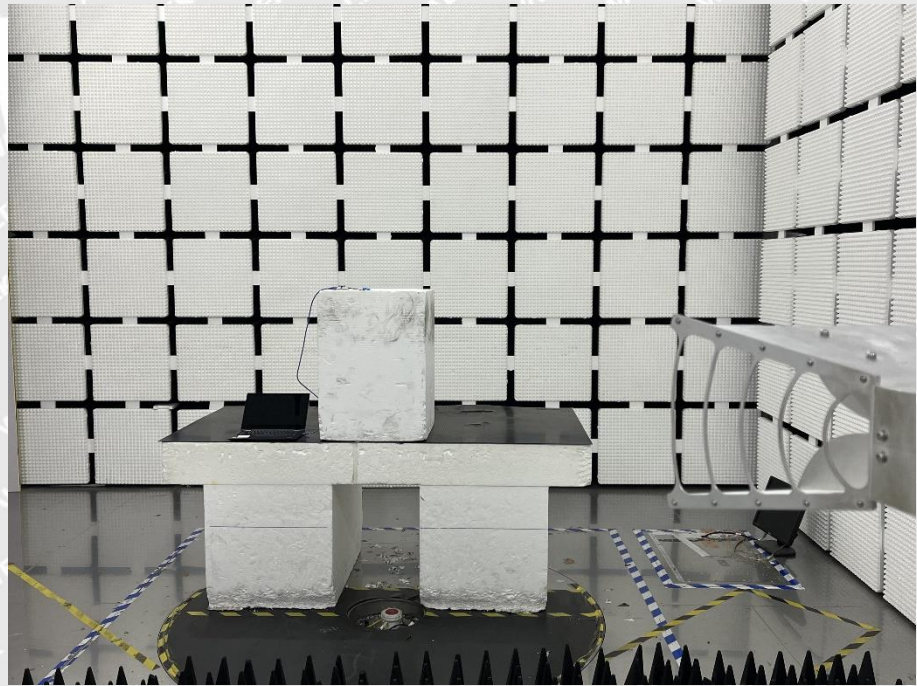

\*\*\*\*\* END OF REPORT \*\*\*\*\*